

## Lyftkraft

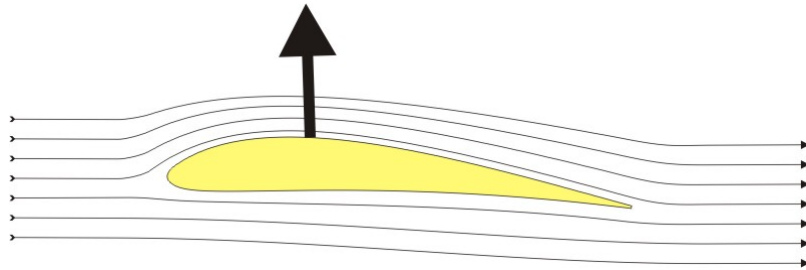

## Motstånd

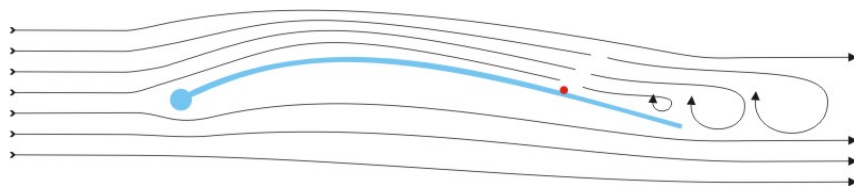

## Bukdjup

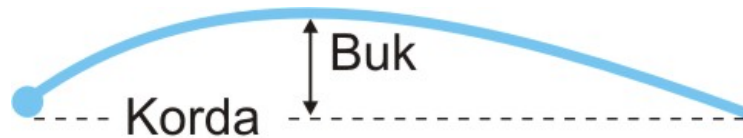

$$\text{Buk/Korda} = \text{Bukdjup (\%)}$$

## Bukposition

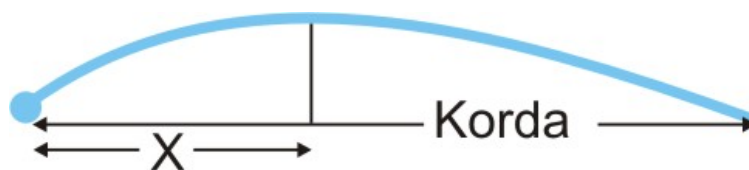

$$X/\text{Korda} = \text{Bukposition (\%)}$$

## Anfallsvinkel

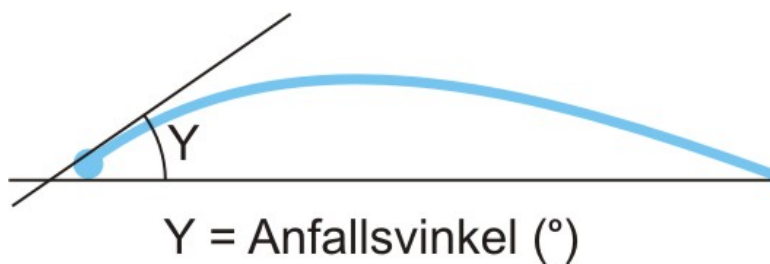

## Vertikal vindgradient

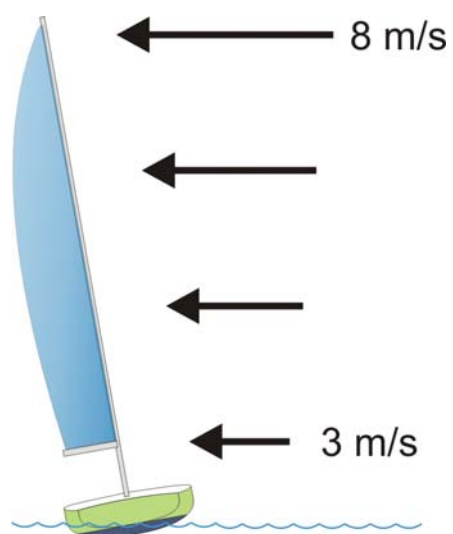

## Skenbar vind

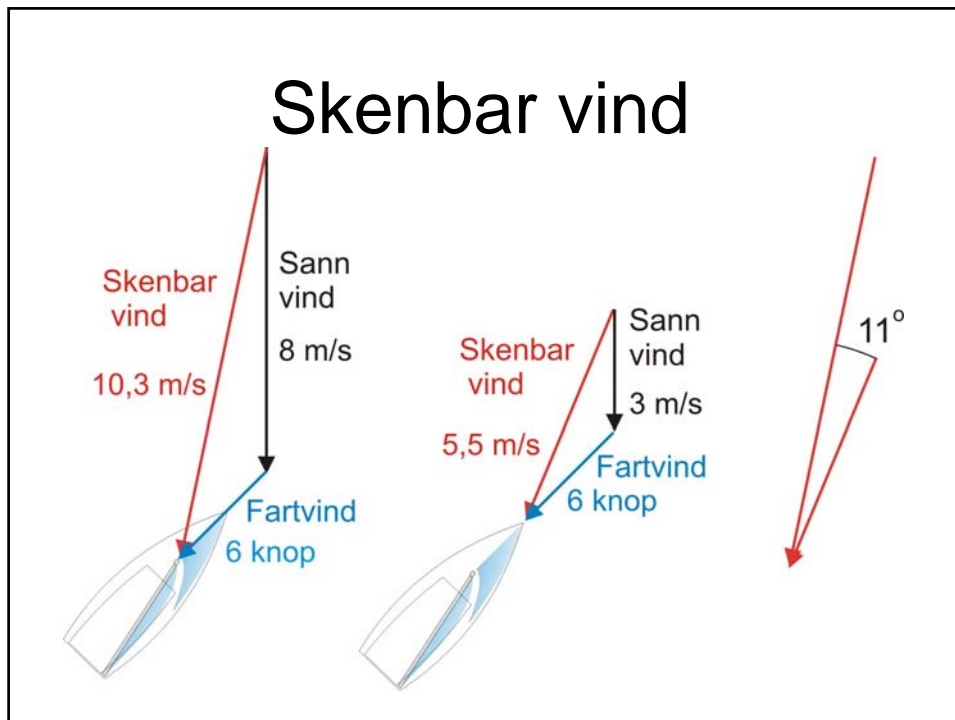

## Vertikal bukfördelning

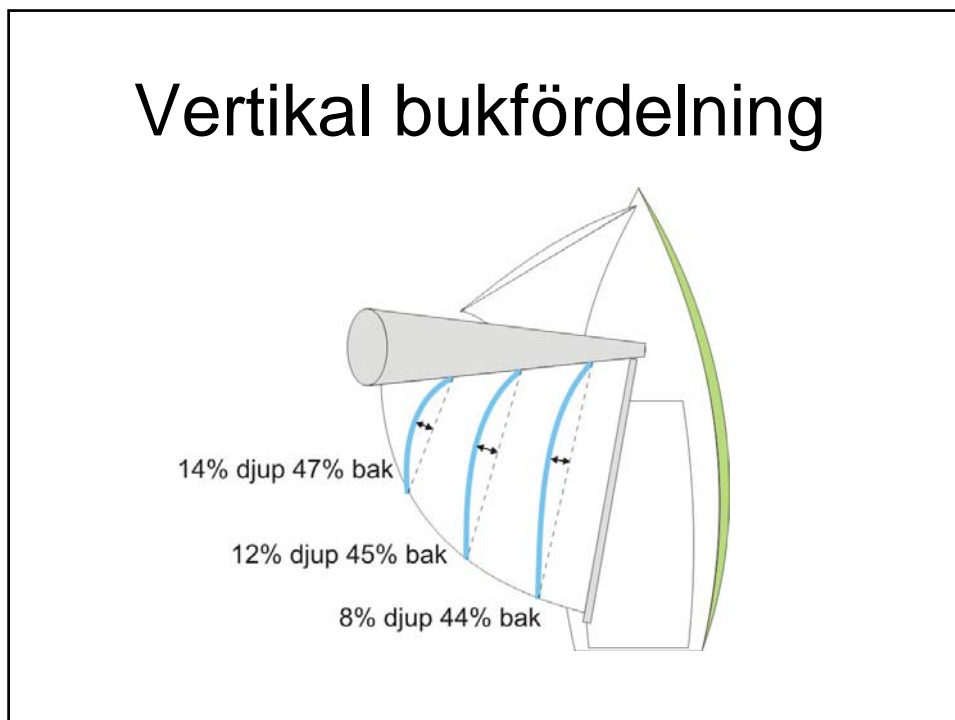

## Vertikal bukfördelning

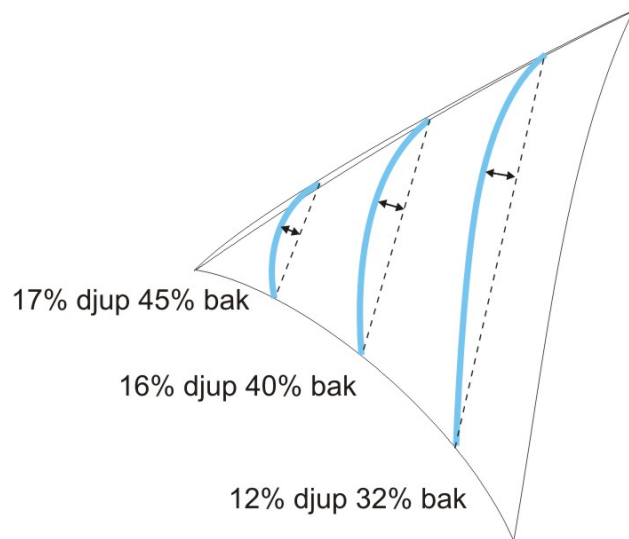

## twist

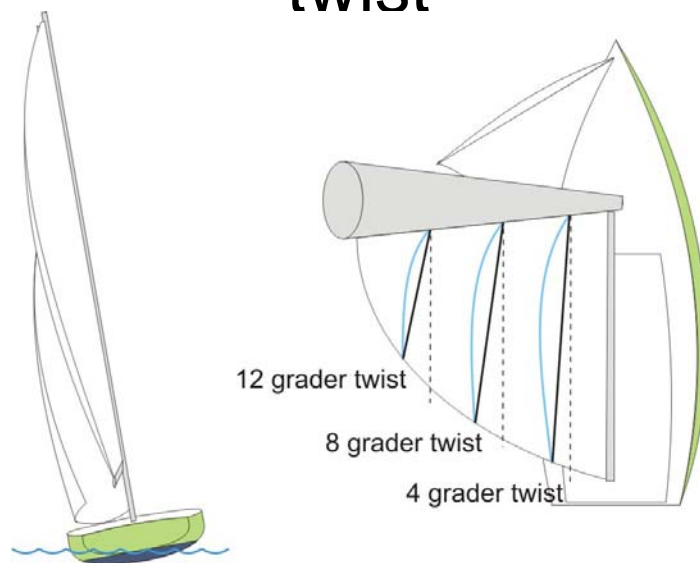

## Storseglets trim

- Ställ in seglets twist med storskot
- Ställ in bukdjup med mastböj och uthal
- Ställ in bukposition med cunningham
- Ställ in totalkraft med travaren

## Storseglets twist

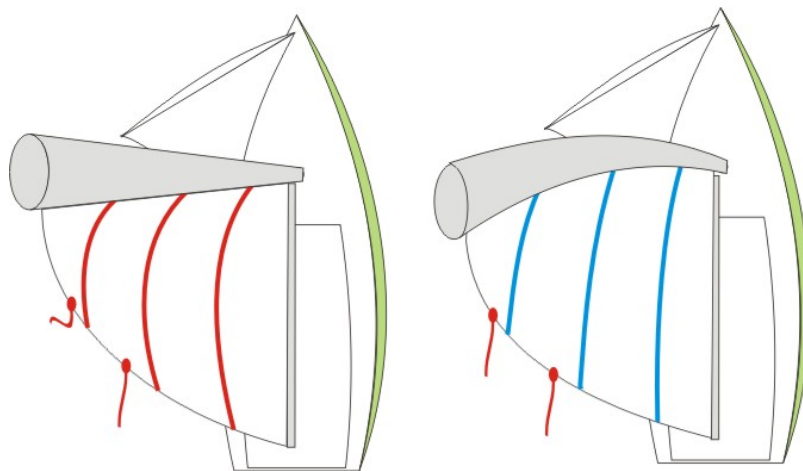

## Storseglets bukdjup

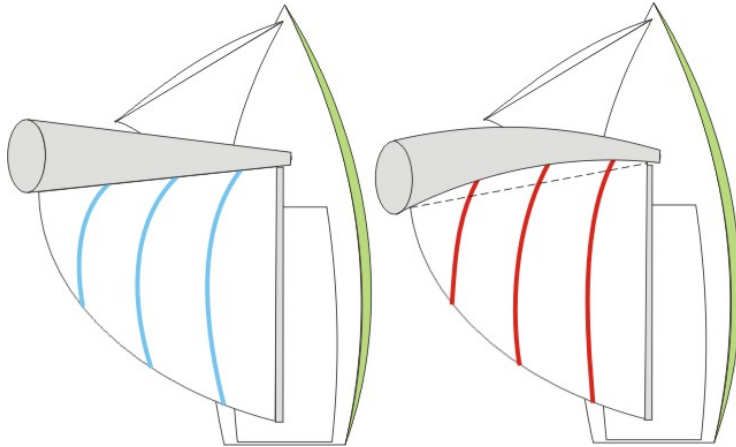

## Storseglets bukdjup

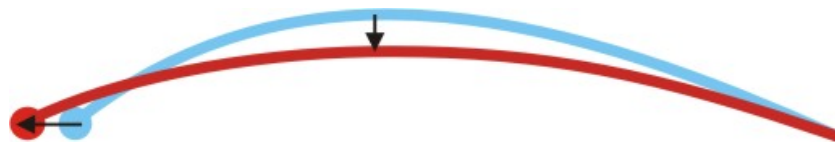

## Överböjningsrynkor

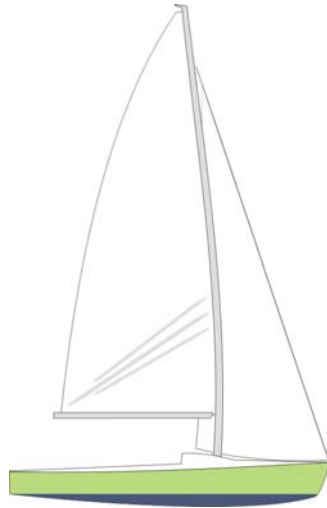

## Storseglets bukdjup

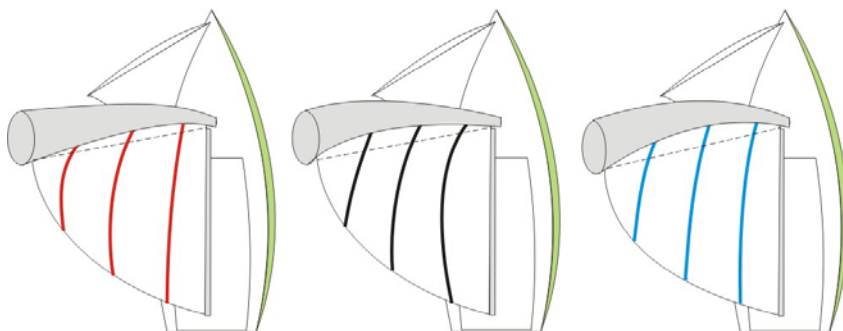

## Bukdjup i undre delen av storseglet

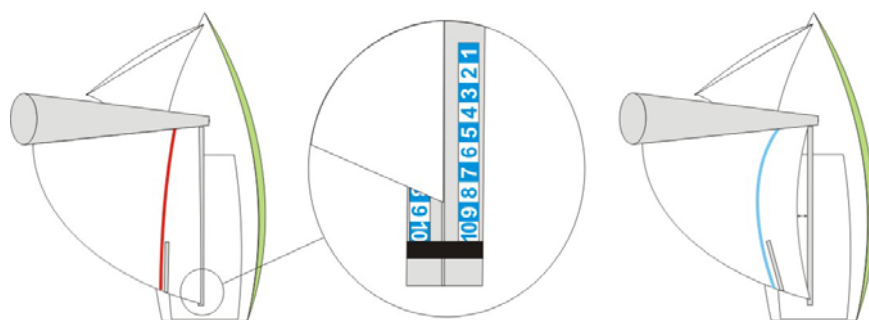

## Storseglets bukposition

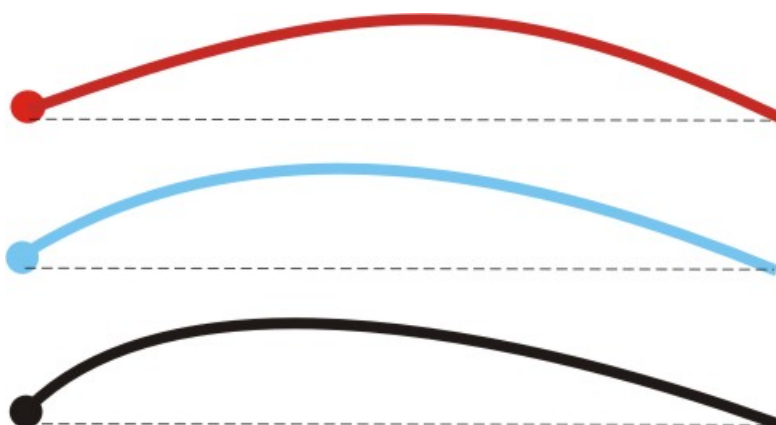

## "Speedwrinkles"

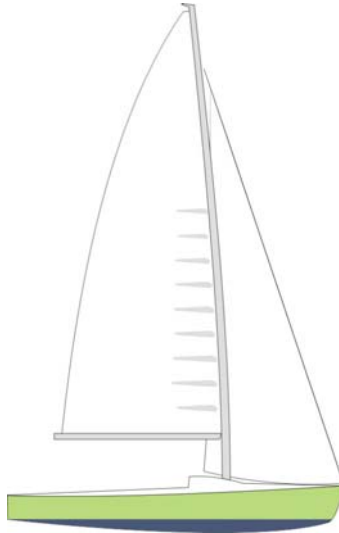

## Storseglets totalkraft

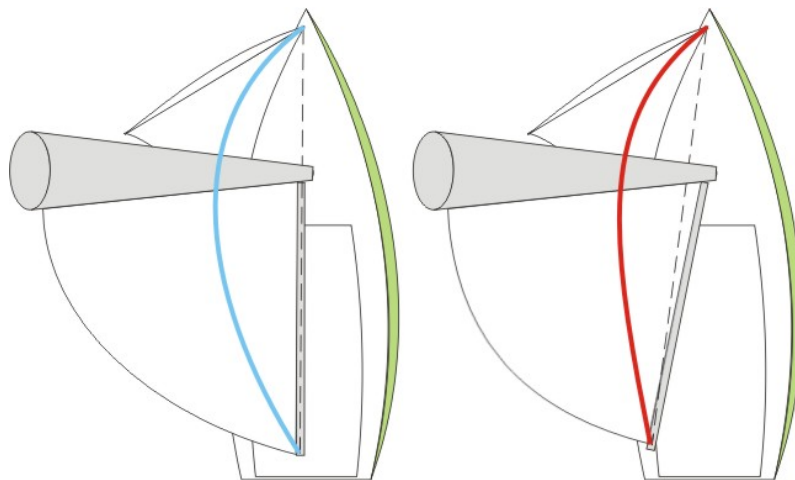



## Spinnakertrim

- Spinnakerbommens höjd
- Spinnakerbommens vinkel mot vinden
- Skotpunkt (Sugga)
- Skotning

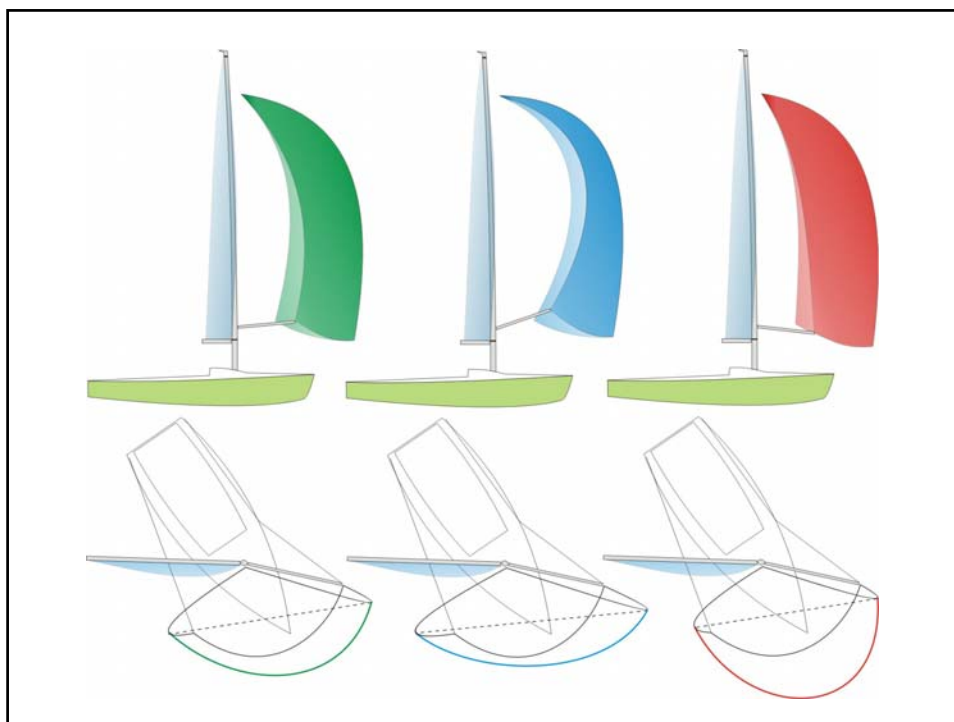

## Spinnbomens vinkel mot vinden

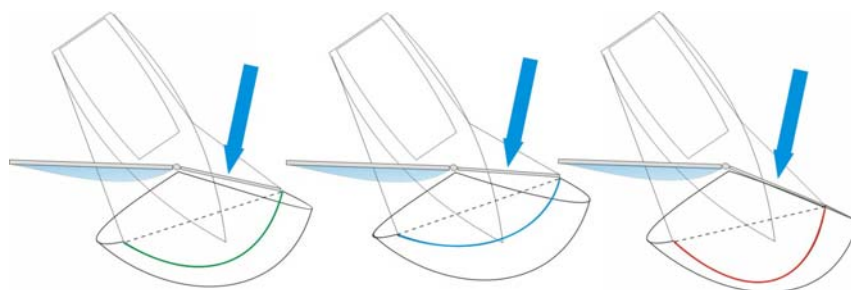

## Spinnakerbommens höjd på slör

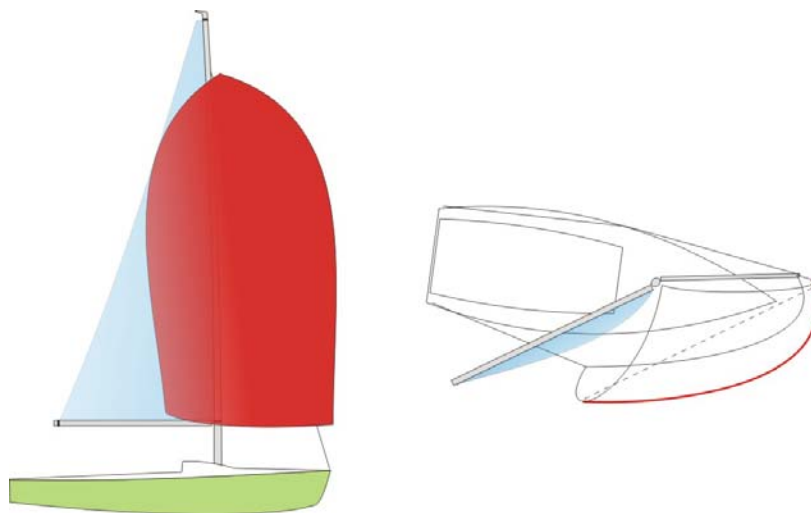

## Spinnakerbommens höjd på slör

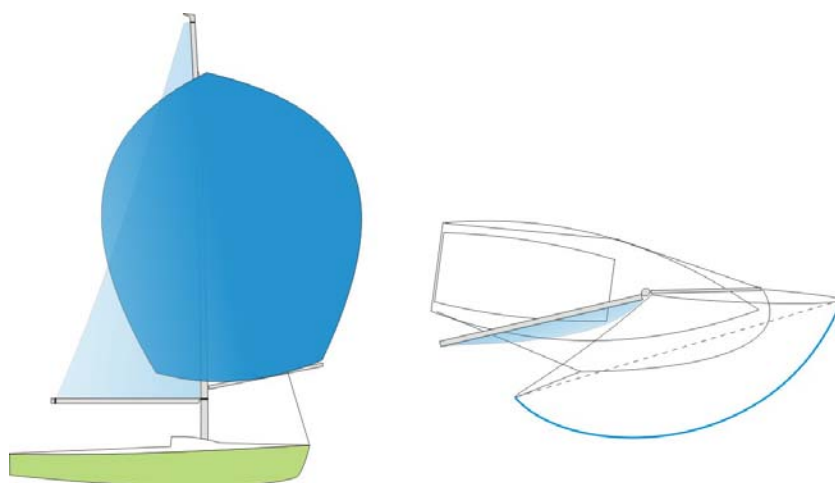



## Gennaker



## G-0

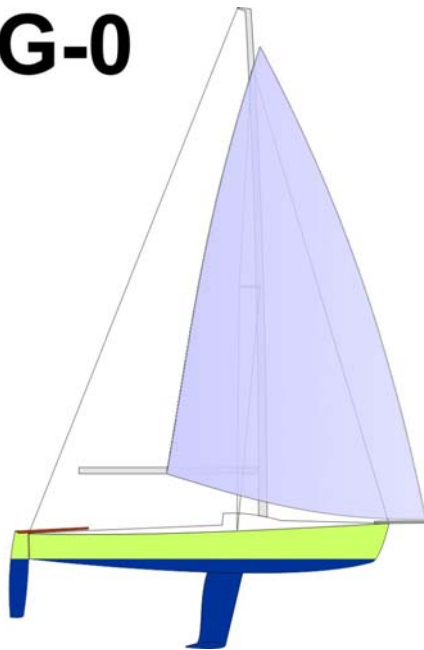

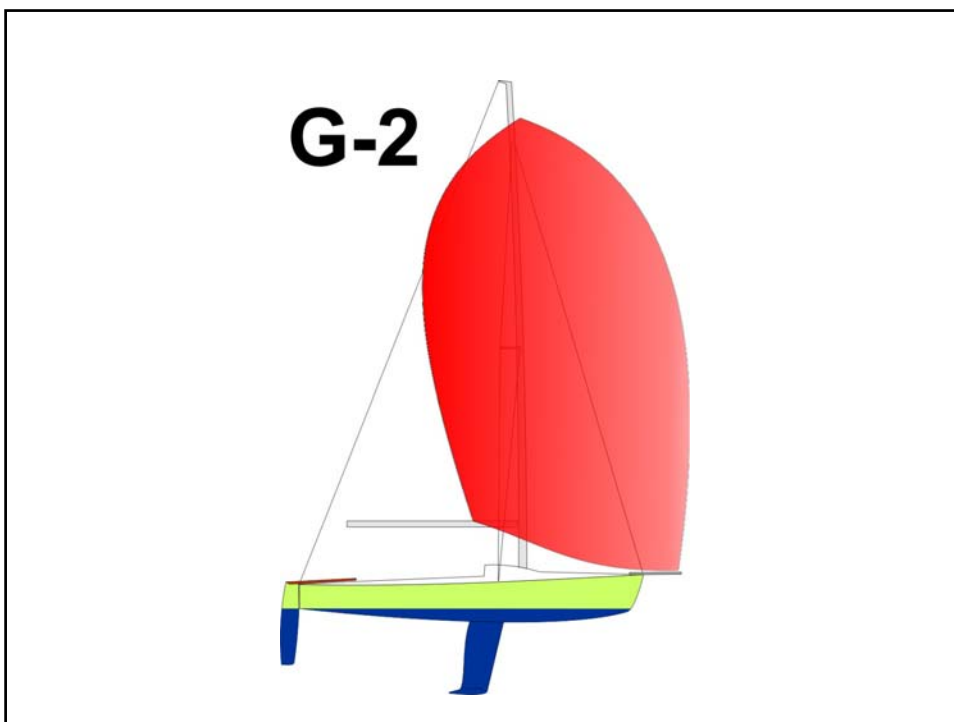

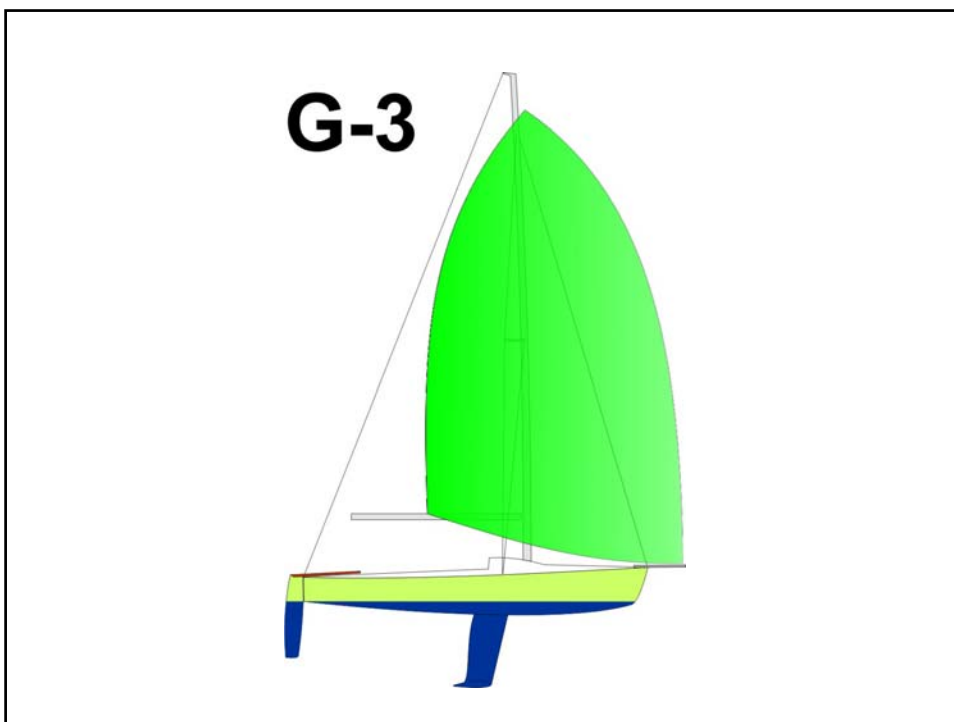

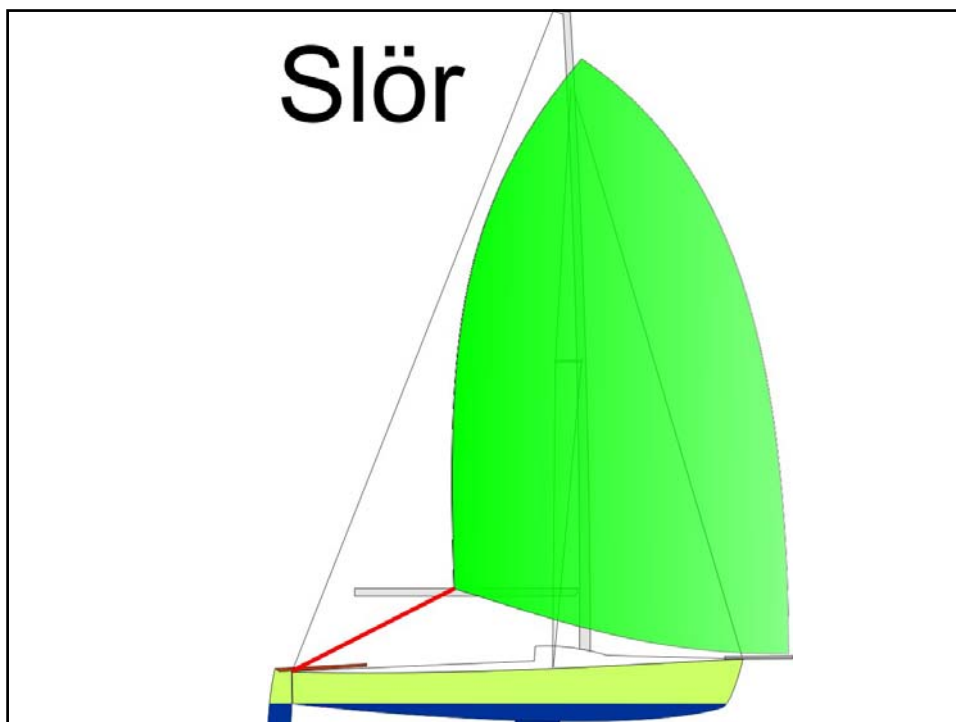

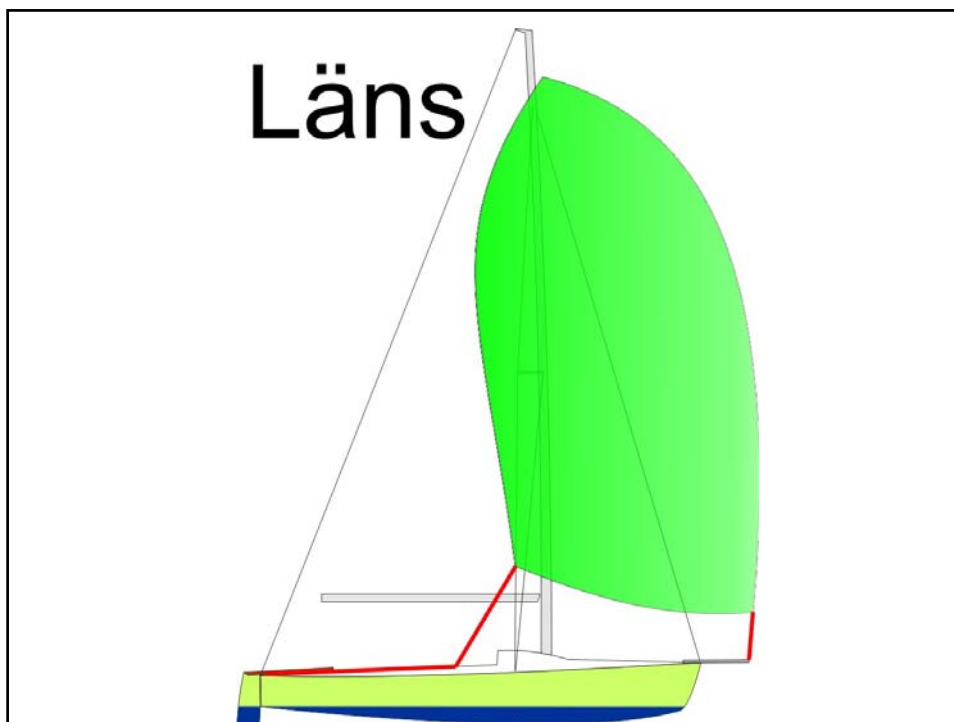



## Styrkevid undanvind

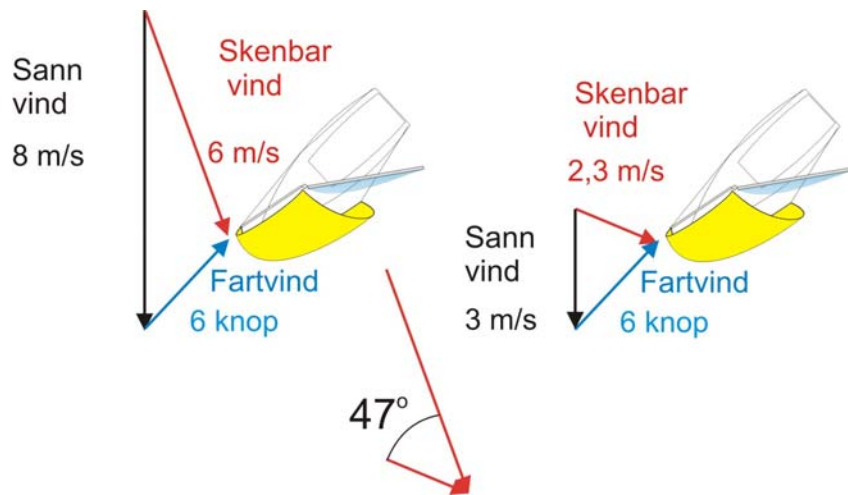

## VMG

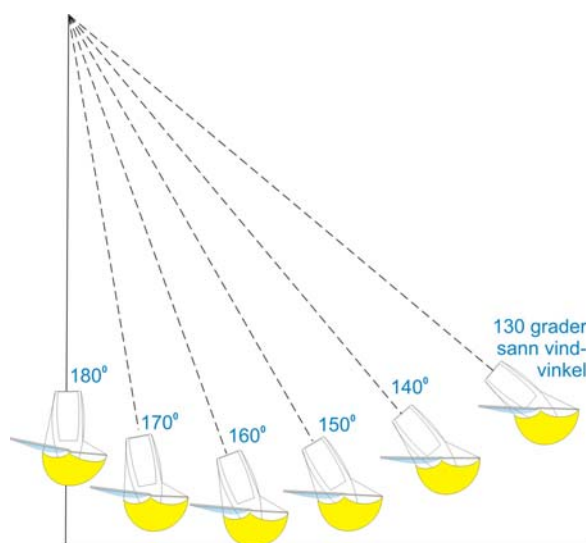



## "The downwind cliff"

